

OWNER'S GUIDE

PRODUCT LINE:

Simply Cinema

MODEL NUMBER: **TRIO135** | **SATPair135**

DESIGN GOAL: Bring the thrill of live performance and movie sound to the home environment by calling on JBL's professional engineering leadership.

TWEETER TYPE: Titanium-laminate-dome

ENCLOSURE TYPE: Sealed

PROFESSIONAL REFERENCE: Cinema Loudspeaker Series

JBL

THANK YOU FOR CHOOSING JBL

For more than 50 years, JBL has been involved in every aspect of music and film recording and reproduction, from live performances to the recordings you play in your home, car or office.

We're confident that the JBL system you have chosen will provide

every note of enjoyment that you expected – and that when you think about purchasing additional audio equipment for your home, car or office, you will once again choose JBL.

Please take a moment to complete the enclosed profile card. It enables

us to keep you posted on our latest advancements, and helps us to better understand our customers and build products that meet their needs and expectations.

JBL Consumer Products

INCLUDED

TRIO135

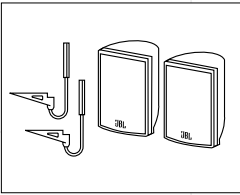

Two satellites for left and right or surrounds with wall-mount brackets.

SATPair135

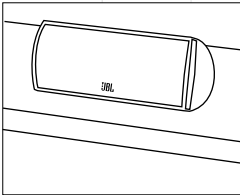
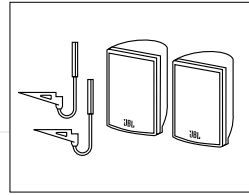

One center-channel speaker with adjustable support leg.

For a complete system, consider adding a powered subwoofer. Please see your JBL dealer for assistance.

SPEAKER PLACEMENT

Front Speakers

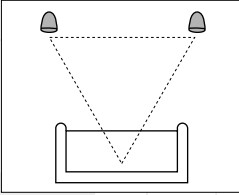

Center-Channel Speaker (not included with SATPair135)

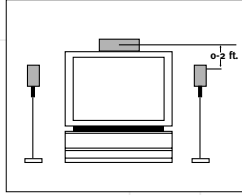

Surround Speakers

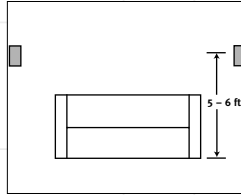
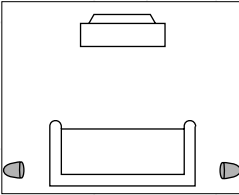

The front speakers should be placed the same distance from each other as they are from the listening position. They should be placed at about the same height from the floor as the listeners' ears will be, or they may be angled toward the listeners.

The center-channel speaker (not included with SATPair135) should be placed slightly behind the front left and right speakers, and no more than two feet above or below the tweeters of the left and right speakers. It is often convenient to set the center speaker on top of the television set, as shown in the drawing. Use the supplied support leg to aim it toward the listener

by screwing the leg in to angle the speaker up, or unscrewing the leg slightly to angle the speaker down.

The two surround speakers should be placed slightly behind the listening position and, ideally, should face each other and be at a level higher than the listeners' ears. If that is not possible, they may be placed on a wall behind the listening position, facing forward. The surround speakers should not call attention to themselves. Experiment with their placement until you hear a diffuse, ambient sound accompanying the main-program material heard in the front speakers.

The SATPair135 speakers are perfect for bringing music to additional rooms in your home. If your receiver or amplifier is equipped with A/B speaker switching, simply connect the pair of speakers to the unused pair of speaker terminals on your receiver, following the directions in the Speaker Connections section on page 5. If you plan on playing both pairs of speakers simultaneously, check with the manufacturer of your receiver or amplifier to find out whether that use is recommended.

MOUNTING OPTIONS

Satellites and Surrounds

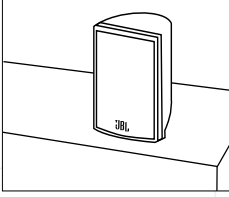

On shelves.

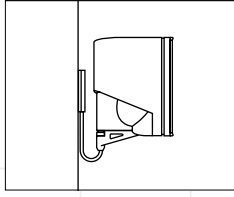

On the wall. Wall brackets are included for the satellite speakers only.

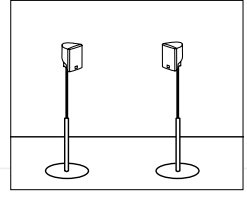

On optional stands (FS300).

Wall-Mounting

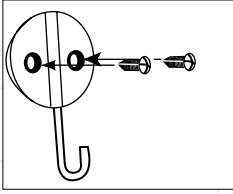

Attach plate to wall. The brackets should be placed, if possible, so that the screws will fasten into a wooden wall stud. If that is not possible, use properly selected wall anchors.

The customer is responsible for proper selection and use of mounting hardware, available through hardware stores, to properly and safely wall-mount the speakers.

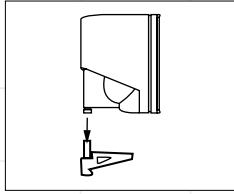

Slide speaker onto support.

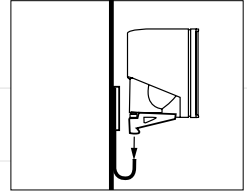

Place speaker and support on wall plate.

SPEAKER CONNECTIONS

Connection Tips

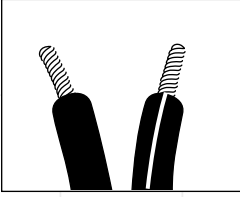

Separate and strip the ends of the speaker wire as shown. Speakers and electronics terminals have corresponding (+) and (-) terminals. Most manufacturers of speakers and electronics, including JBL, use red to denote the (+) terminal and black for the (-) terminal. To use the spring-type terminals, simply press the colored terminal, insert the bare end of the wire into the hole, and release. The clip inside the terminal grips the wire. Tug the wire gently to make sure that it has been inserted properly.

The (+) lead of the speaker wire is usually indicated by a stripe, ridges in the wire insulation, or gold-colored strands inside clear wire insulation. It is important to connect both speakers identically: (+) on the speaker to (+) on the amplifier and (-) on the speaker to (-) on the amplifier. Wiring “out of phase” results in thin sound, weak bass and a poor stereo image.

With the advent of multichannel surround-sound systems, connecting all of the speakers in your system with the correct polarity remains equally important in order to preserve the proper ambience and directionality of the program material.

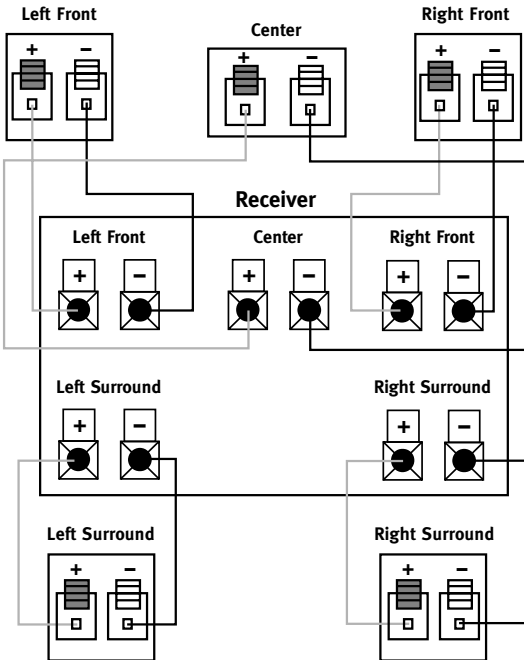

TROUBLESHOOTING

If there is no sound from any of the speakers:

- Check that receiver/amplifier is on and a source is playing.
- Check all wires and connections between receiver/amplifier and speakers. Make sure all wires are connected. Make sure none of the speaker wires are frayed, cut or punctured.
- Review proper operation of your receiver/amplifier.

If there is no sound coming from one speaker:

- Check the “Balance” control on your receiver/amplifier.
- Check all wires and connections between receiver/amplifier and speakers. Make sure all wires are connected. Make sure none of the speaker wires are frayed, cut or punctured.
- In Dolby* Digital or DTS® modes, make sure that the receiver/processor is configured so that the speaker in question is enabled.

If there is no sound from the center speaker (TRIO135 only):

- Check all wires and connections between receiver/amplifier and speaker. Make sure all wires are connected. Make sure none of the speaker wires are frayed, cut or punctured.
- If your receiver/processor is set in Dolby Pro Logic* mode, make sure the center speaker is not in phantom mode.
- If your receiver/processor is set in Dolby Digital or DTS

mode, make sure the receiver/processor is configured so that the center speaker is enabled.

If the system plays at low volumes but shuts off as volume is increased:

- Check all wires and connections between receiver/amplifier and speakers. Make sure all wires are connected. Make sure none of the speaker wires are frayed, cut or punctured.
- If more than one pair of main speakers is being used, check the minimum impedance requirements of your receiver/amplifier.

If there is low (or no) bass output:

- Make sure the connections to the left and right “Speaker Inputs” have the correct polarity (+ and –).
- Consider adding a powered subwoofer to your system. See your JBL dealer for further assistance.
- If you are using a powered subwoofer, check your owner’s manual to make sure it is correctly connected and is being used according to the manufacturer’s instructions.

If there is no sound from the surround speakers:

- Check all wires and connections between receiver/amplifier and speakers. Make sure all wires are connected. Make sure none of the speaker wires are frayed, cut

or punctured.

- Review proper operation of your receiver/processor and its surround-sound features.
- Make sure the movie or TV show you are watching is recorded in a surround-sound mode. If it is not, check to see if your receiver/processor has other surround modes you may use.
- In Dolby Digital or DTS modes, make sure your receiver/processor is configured so that the surround speakers are enabled.
- Review the operation of your DVD player and the jacket of your DVD to make sure that the DVD features the desired Dolby Digital or DTS mode, and that you have properly selected that mode using both the DVD player’s menu and the DVD disc’s menu.



Staple sales invoice here.

SPECIFICATIONS

Satellites

Frequency Response

200 – 20kHz (–6dB)

Recommended Power

10 – 50 watts

Impedance

8 ohms nominal

Sensitivity

86dB @ 1 watt/1 meter

Tweeter

One 1/2" titanium-laminate dome, video-shielded

Midrange

One 3" driver, video-shielded

Dimensions (H x W x D)

4-3/8" x 3-3/16" x 3-3/4"

111mm x 81mm x 95mm

Weight

1.1 lb/0.5kg

Center (TRIO135 only)

Frequency Response

200 – 20kHz (–6dB)

Recommended Power

10 – 50 watts

Impedance

8 ohms nominal

Sensitivity

86dB @ 1 watt/1 meter

Tweeter

One 1/2" titanium-laminate dome, video-shielded

Midrange

Dual 3" drivers, video-shielded

Dimensions (H x W x D)

3-1/4" x 7-5/8" x 3-3/4"

83mm x 194mm x 95mm

Weight

1.89 lb/0.86kg

Refinements may be made on occasion to existing products without notice, but will always meet or exceed original specifications unless otherwise stated.

Simply Cinema is a registered trademark of JBL, Incorporated.

* Dolby and Pro Logic are trademarks of Dolby Laboratories.

DTS is a registered trademark of Digital Theater Systems, Inc.

Declaration of Conformity



We, Harman Consumer International
2, route de Tours
72500 Chateau-du-Loir
FRANCE

declare in own responsibility, that the products described in this owner's manual are in compliance with technical standards:

EN 50081-1:1992

EN 50082-1:1992

Steen Michaelsen
Harman Consumer International
Chateau-du-Loir, FRANCE. 5/00

OWNER'S GUIDE

PRODUCT LINE:*Simply Cinema***MODEL NUMBER: TRIO135 SATPair135**

DESIGN GOAL: Bring the thrill of live performance and movie sound to the home environment by calling on JBL's professional engineering leadership.

TWEETER TYPE: Titanium-laminate-dome

ENCLOSURE TYPE: Sealed

PROFESSIONAL REFERENCE: Cinema Loudspeaker Series

JBL**PRO SOUND
COMES HOME™**

JBL Consumer Products
250 Crossways Park Drive, Woodbury, NY 11797
8500 Balboa Boulevard, Northridge, CA 91329
800-336-4JBL (4525) (USA only)
www.jbl.com

©2000 JBL, Incorporated.

JBL is a registered trademark of JBL, Incorporated.

Part No. ai5077

H A Harman International Company